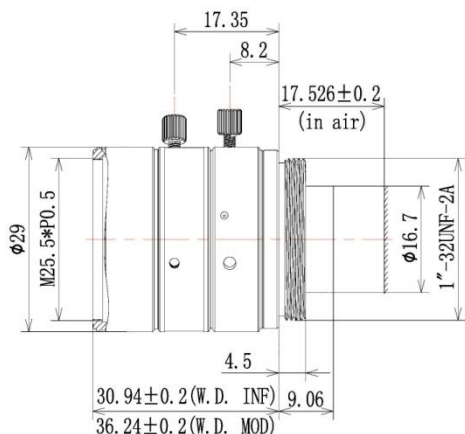

FEATURES

- ◆ Brand: ZLKC
- ◆ 2/3" C-Mount 25mm F2.0 10MP
- ◆ Shorter Working Distance
- ◆ Ensures Corner Brightness
- ◆ Nominal Distortion Design
- ◆ Compact design

SPECIFICATION
Low WD Lenses 25mm 2/3" C Mount 10MP

Model	LM2520MP10	
Image circle	2/3-inch (Φ 11.4)	
Focal length	25mm ±5%	
F No.	F2.0-16	
M.O.D(m)	0.2-Inf.	
Operation	Iris	Manual
	Focus	Manual
Horizontal Angle of View	2/3"Type	23.9°×18.3°×15.4°
	1/1.8"Type	19.4°×15.8°×10.7°
	1/2"Type	17.4°×14.0°×10.5°
Distortion	At 0.4m	-0.14%
Back focal length	9.97mm	
Flange Back Focal Length	17.526mm	
Mount	C-Mount	
Relative Illumination	63%	
(CRA)	7.5°	
Dimension	Φ29x30.94mm	
Weight	59.5g	
(Lens structure)	5groups, 8elements	
Filter Thread	M25.5*P0.5	
Working Temperature	-20°C ~ +60°C	