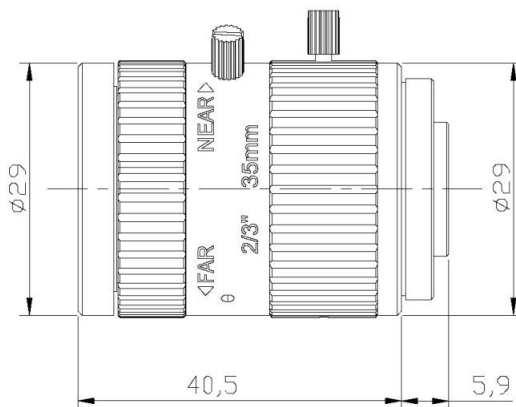

FEATURES

- ◆ Brand: ZLKC
- ◆ 2/3" C-Mount 35mm F2.8 10MP
- ◆ Design the high-resolution
- ◆ Can suppress stray light
- ◆ Low distortion, NIR Sensitivity
- ◆ Compact & Small volume

SPECIFICATION

10MP 35mm FA Lens C Mount		Working Distance	Magnification	2/3" Field of View (mm)		
Model	VM3528MP10	mm	X	H	V	
Image Size	2/3-inch	1000	0.035X	241.13	200.42	
Focal length	35mm	950	0.037X	228.65	190.05	
F No.	F2.8-16	900	0.039X	216.19	179.69	
M.O.D(m)	0.15-Inf.	850	0.041X	203.73	169.33	
Operation	Iris	Manual	800	0.044X	191.26	158.97
	Focus	Manual	750	0.047X	178.80	148.61
Horizontal Angle of View (D×H×V)	2/3"	18.4°×14.8°×11.1°	700	0.050X	166.33	138.25
	1/2"	13.4°×10.8°×8.1°	650	0.054X	153.86	127.88
	1/3"	10.1°×8.1°×6.1°	600	0.058X	141.39	117.52
Distortion	-0.17%	550	0.064X	128.93	107.16	
BFL	13.63mm	500	0.070X	116.45	96.79	
Flange FL	17.526mm	450	0.078X	103.99	86.44	
Mount	C-Mount	400	0.088X	91.53	76.07	
Object Dimension	41.6mm×34.6mm(WD=200mm)	350	0.100X	79.06	65.69	
Dimension	Φ29×40.5mm	300	0.117X	66.59	55.34	
Weight	64.8g	250	0.140X	54.12	44.98	
Filter	M27 P=0.5mm	200	0.175X	41.66	34.62	
Working Temperature	-20°C ~ +60°C	150	0.233X	30.03	24.96	